

STEP 1 / 第1步

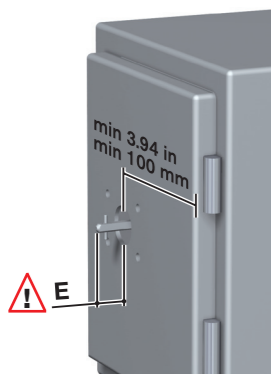

STEP 2 / 第2步

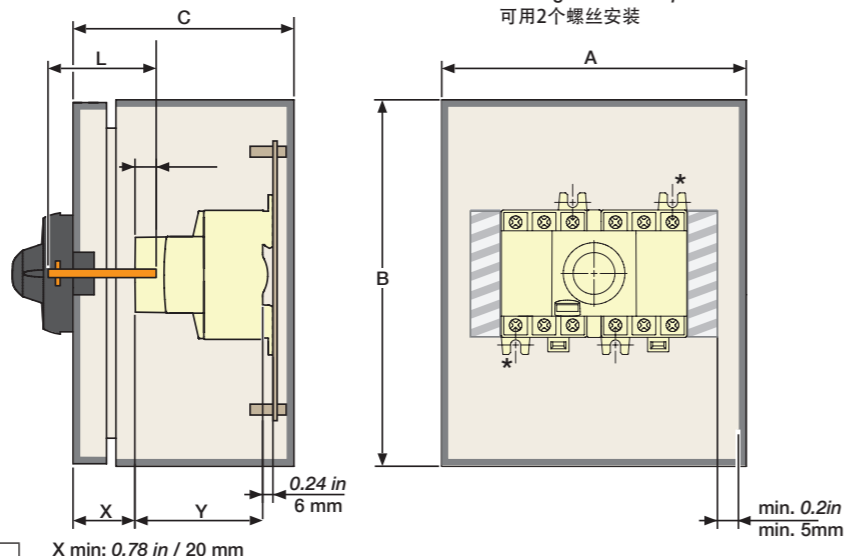

* Possible assembly with two screws
Montage avec 2 vis possible
可用2个螺丝安装

	L	min./最小	E	max./最大
Type S000	L = X + 0.98 in L = X + 25 mm	0.31 in / 8 mm	0.39 in / 10 mm	
Type S0 / S00	L = X + 1.18 in L = X + 30 mm	0.51 in / 13 mm	0.59 in / 15 mm	
Type S01	L = X + 1.43 in L = X + 36.5 mm	0.68 in / 17,5 mm	0.84 in / 21,5 mm	

Dual dimensions in/mm
Double dimensions in/mm
Doble dimensiones in/mm
双单位尺寸

Add. Pole
Pôle additionnel
Polo adicional
附加极



Aux. Contacts
Contacts aux.
Contactos auxiliares
辅助触点

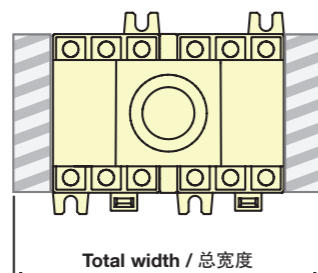

Total width / 总宽度 =
A1 + x A2 + y A3

if/如果 x = 0 y = 4 max/最大
if/如果 x = 1 y = 3 max/最大
if/如果 x = 2 y = 2 max/最大

Switch / Interrupteur / Interruptor

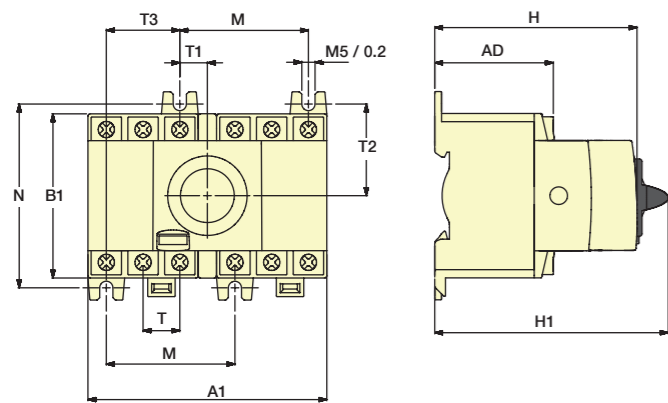

	M16 to/到 M40 - M CD63		M63 - M80 - M CD100	
	in	mm	in	mm
A	5.51	140	6.69	170
A (UL)	10	254	10	254
A1	3.83	97.5	4.13	105
A2	0.59	15	0.68	17.5
A3	0.34	8,8	0.34	8,8
AD	1.90	48,5	1.90	48,5
B	5.78	147	7.83	199
B (UL)	8	203.2	8	203.2
B1	2.67	68	3	76
C	4.33	110	4.33	110
C (UL)	4	101.6	4	101.6
H	3.30	84	3.30	84
H1	3.74	95	3.74	95
N	2.95	75	3.35	85
M	2.06	52,5	2.06	52,5
T	0.59	15	0.68	17,5
T1	0.44	11,25	0.34	8,75
T2	1.47	37,5	1.67	42,5
T3	1.18	30	1.38	35
Z min.	0.39	10	0.39	10
Z max.	0.59	15	0.59	15

KIT CHANGEOVER SWITCH/转换开关功能组件 / SWITCH 6P/8P/极开关组件
M 16 - M 20 - M 25 - M 32 - M 40 - M CD63
KIT CHANGEOVER SWITCH/转换开关功能组件 / SWITCH 6P/8P/极开关组件
M 63 - M 80 - M CD100



- GB Instruction sheet
- F Notice d'utilisation
- E Instrucciones de servicio
- CN 说明书

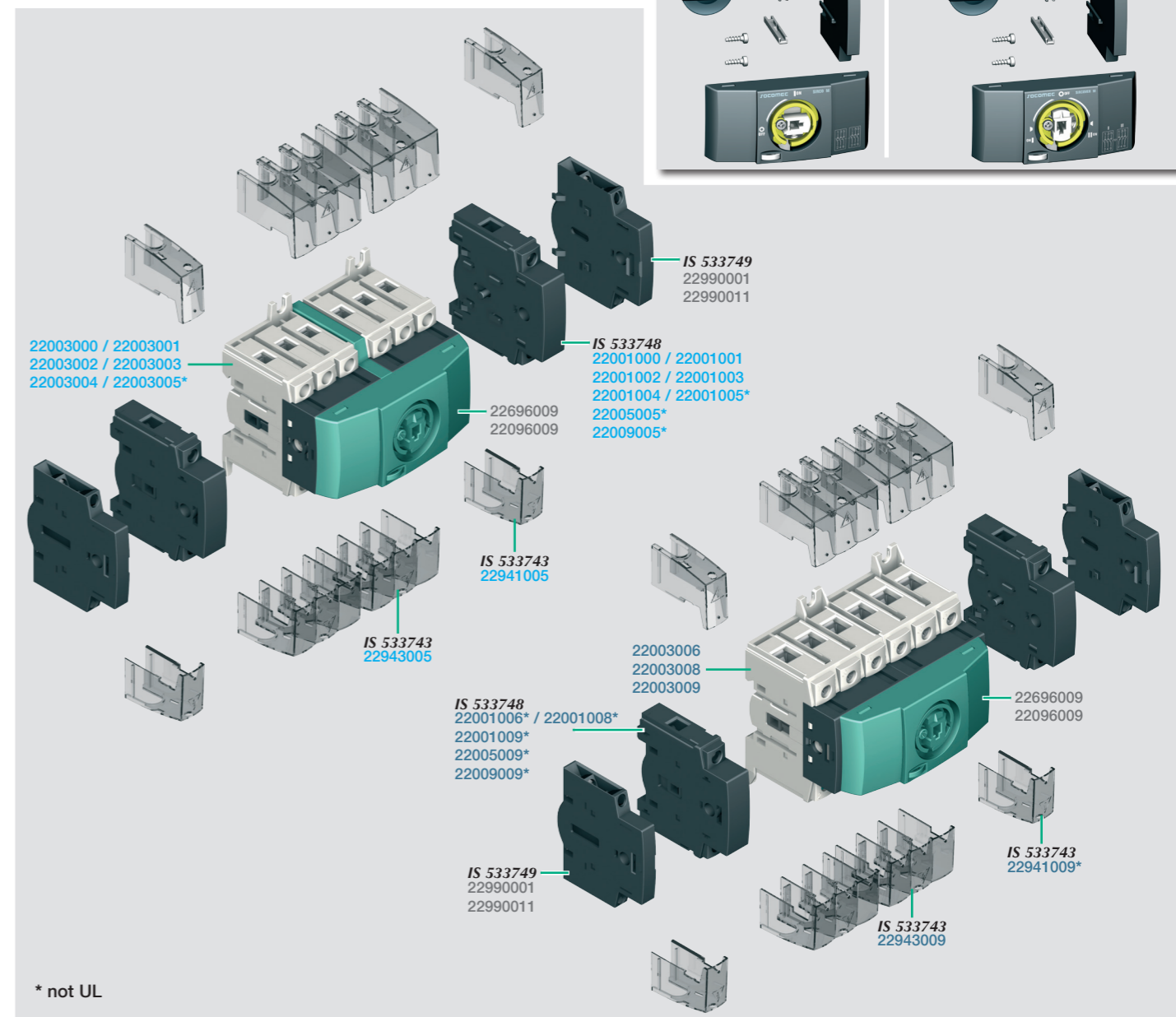
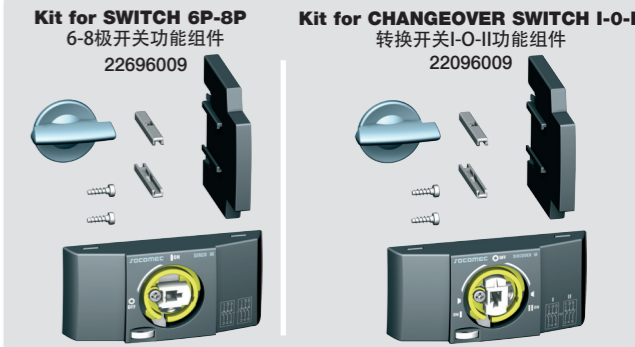

Edition 01/17 - IS 533752- H / RECTO-VERSO / S blanc offset quadri 80g/m²

* not UL

M16 to/到 M40 - M CD63		M63 - M80 - M CD100	
Wire / Câble / Cable / 电缆	Torque / Couple / Par de apriete / 扭矩	Wire / Câble / Cable / 电缆	Torque / Couple / Par de apriete / 扭矩
1,5 mm ² - 16 mm ² 14 - 4 AWG stranded 14 - 10 AWG solid 2x14 - 2x12 AWG stranded 2x12 AWG solid	26.5 lb.in / 3 Nm	2,5 mm ² - 35 mm ² 14 - 1 AWG stranded 14 - 10 AWG solid 2x10 - 2x6 AWG stranded 2x12 AWG solid	39.8 lb.in / 4.5 Nm

Use copper conductors only, 75°C or higher.
只能使用铜缆 75°C或更高
Flat 6,5 / 一字螺丝刀
Pozidriv 2 / 十字螺丝刀
0.35 in / 9 mm (M16 to/到 M40 - M CD63)
0.47 in / 12 mm (M63 to/到 M100 - M CD100)
Stripping distance / 绝缘剥离长度

WARNING / ATTENTION / PRECAUCIÓN / 注意
The opening of the branch-circuit protective device may be an indication that a fault has been interrupted. To reduce the risk of fire or electric shock, current-carrying parts and other components of the controller should be examined and replaced if damaged. Suitable for use on circuits capable of delivering not more than 65kA rms symmetrical amperes, 600V AC max. use only class J fuses 30A max. for SIRCO M1 / 100A for SIRCO M2. (Time delay)
La activación del dispositivo de protección frente a derivaciones puede significar que se ha interrumpido una corriente de fallo. Para reducir el riesgo de incendio o de choque eléctrico, las piezas portadoras de corriente y demás componentes del pedido deberán comprobarse y sustituirse en caso de que se encuentren dañados.
支路保护装置动作表示一个故障电流已经被中断。为了减少火灾或触电的危险，通电流部分和其它控制部件应进行检查。如有损坏，必须更换。

HAZARDOUS VOLTAGE. This equipment must be installed and serviced only by qualified electrical personnel. Turn off all power supplying this equipment before working on or inside equipment. Always use a properly rated voltage sensing device to confirm power is off. Replace all devices, doors, and covers before turning on power to this equipment. Failure to follow these instructions will result in death or serious injury.
TENSION PELIGROSA. Solamente el personal de mantenimiento eléctrico especializado deberá instalar y prestar servicios de mantenimiento a este equipo. Desenergice el equipo antes de realizar cualquier trabajo en él. Siempre utilice un dispositivo detector de tensión adecuado para confirmar la desenergización del equipo. Vuelva a colocar todos los dispositivos, las puertas y las cubiertas antes de energizar este equipo. El incumplimiento de estas precauciones podrá causar la muerte o lesiones serias.
危险电压。这类装置必须由专业人员进行安装和维修。在电气装置上或内部进行操作前必须关掉所有外供电电源。使用合适的额定电压测量装置来确认电源已经关掉。在电气装置送电前必须重新放好所有的部件，柜门和开关盖。不遵守以上预警将导致严重伤害或死亡。

Mounting kit for SWITCH 6-8 M 16 to M 40 - M CD63
M16-M40-M CD63 的6-8极开关组件安装

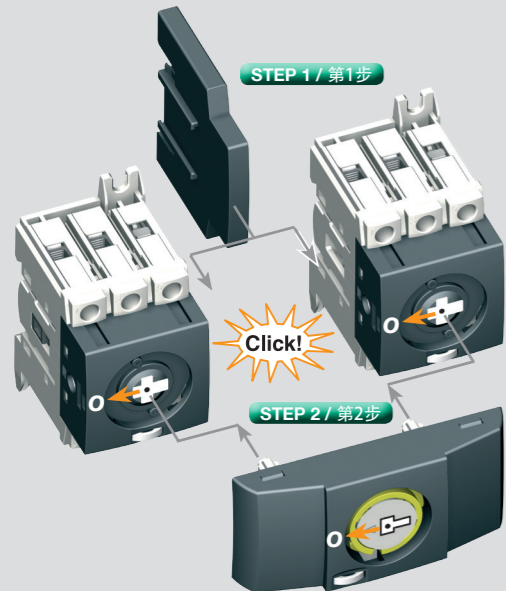

Mounting kit for SWITCH 6/8 M 63 - M 80 - M CD100
M63-M80-M CD100 的6-8极开关组件安装

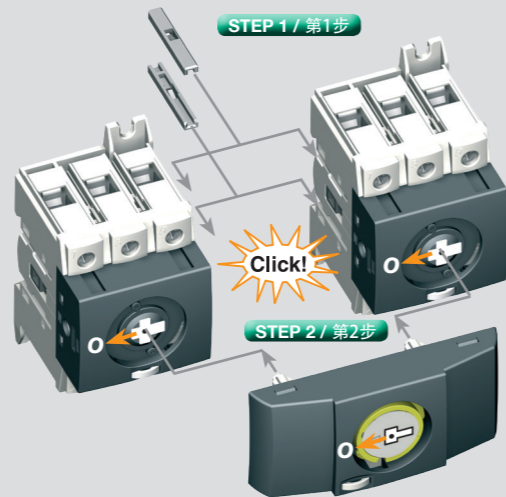

Mounting kit for CHANGEOVER SWITCH I-O-II
M 16 to M 40 - M CD63
M16-M40-M CD63的转换开关I-O-II组件安装

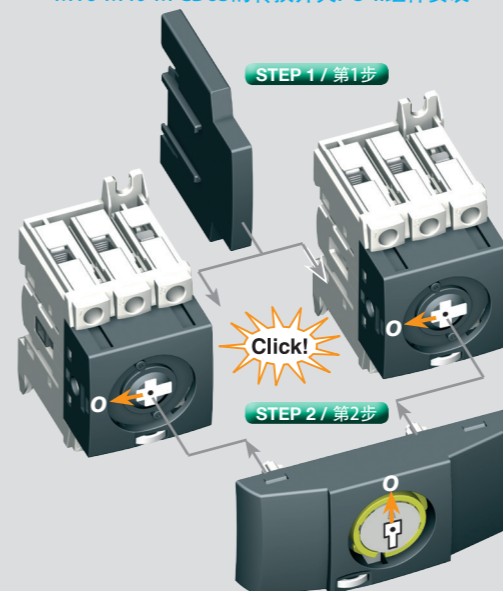

Mounting kit for CHANGEOVER SWITCH I-O-II
M 63 - M 80 - M CD100
M63-M80-M CD100的转换开关I-O-II组件安装

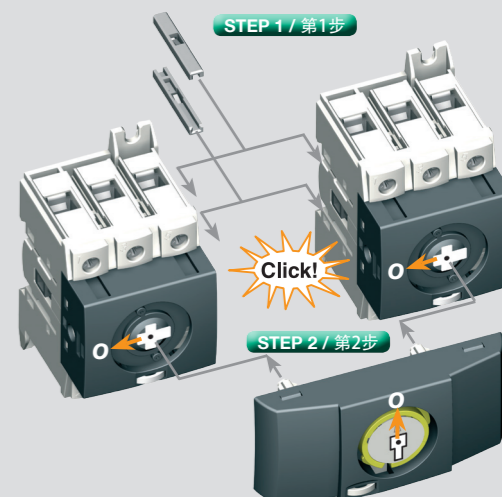

STEP 3 / 第三步

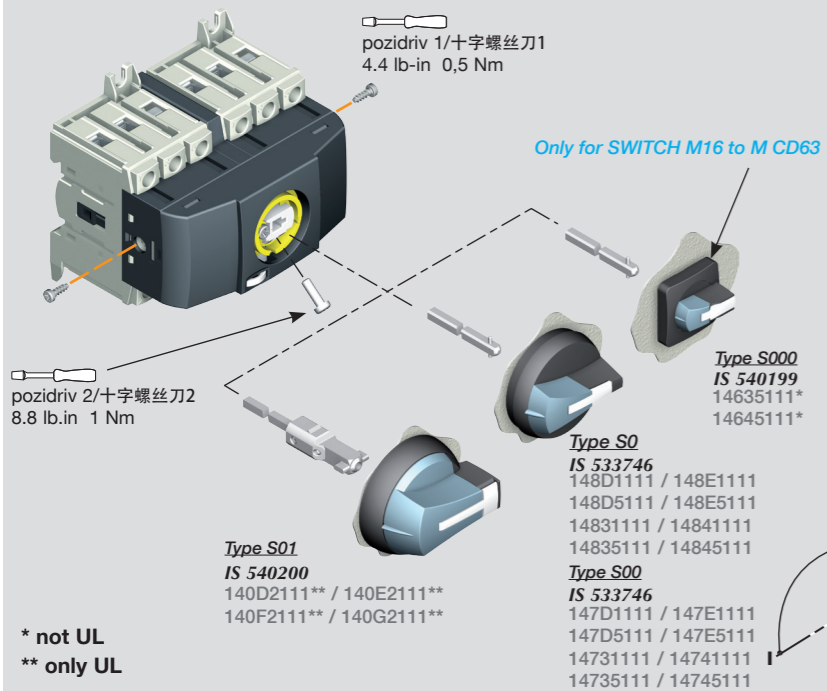

STEP 3 / 第三步

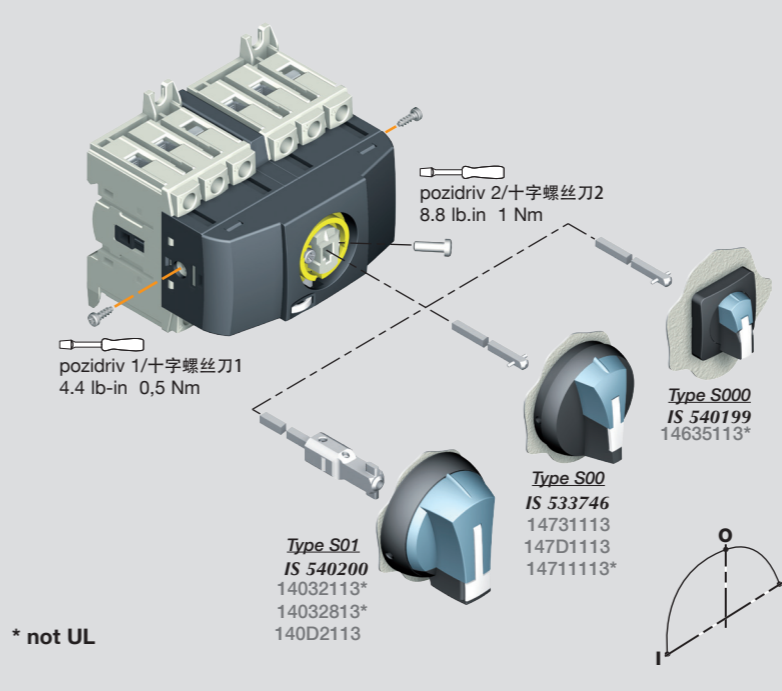

CONFIGURATION
安装方式

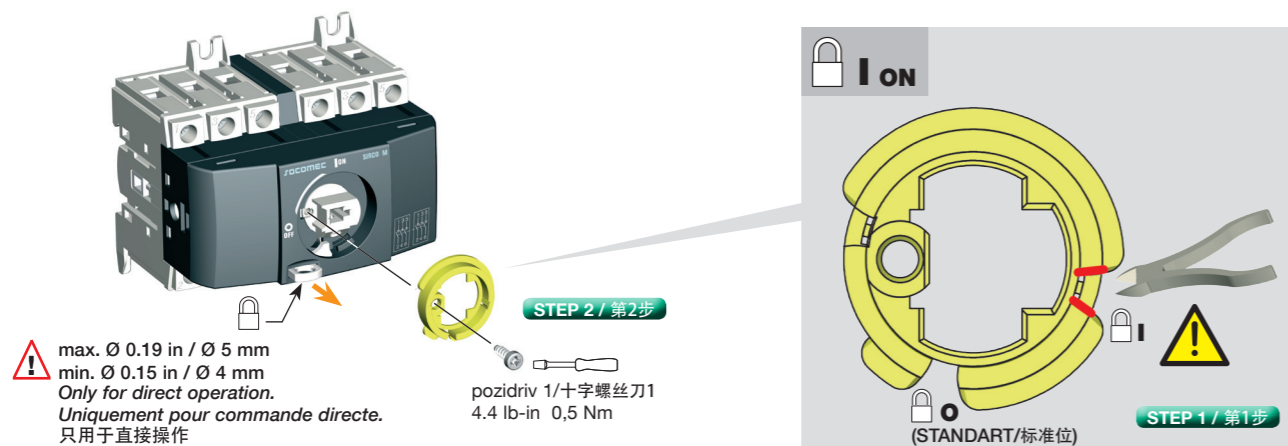

CONFIGURATION
安装方式

